

BT-TRAUMA KIT

Trauma Training Model

USER GUIDE



User Guide



English

■ Cautions

Please read this carefully to ensure correct usage and user's safety through understanding of the product. BT Inc. is not responsible for any accidents occurred by not following the precautions.

- ① Use only components provided or approved by BT Inc.

- ② Do not use the product for any purposes other than described in the manual.

- ③ If you disassemble or modify the product without any permission by BT inc, the warranty will be void. Also, making imitated or altered products for commercial purposes are prohibited by law.

- ④ Keep the product away from water and moisture area.

- ⑤ Do not keep the product near hot or cold environments as possible. Deterioration of product or internal damage may occur from extreme weather conditions.

- ⑥ Never clean the product with chemicals such as solvent, benzene or thinner as these may cause fire ignition or software malfunction. If you did, please wipe off it gently with a soft cloth immediately.

- ⑦ BT Inc. can change or adjust the product specification without any notice in order to improve the product.

Components

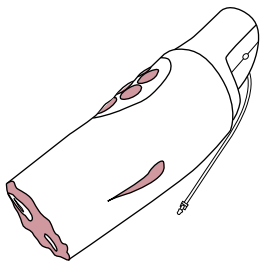

Amputated left leg module (bleeding)

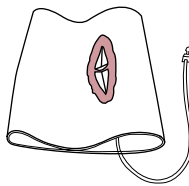

Open fractured right leg module (bleeding)

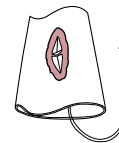

Open fractured right arm module (bleeding)



Laceration



Burn

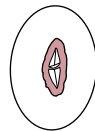

Open fracture



Abrasion

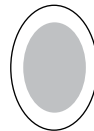

Bruise



Laceration



Burn



Open fracture



Abrasion



Bruise

Attachable wound module (5 cases)

Attachable wound module small size(5 cases)

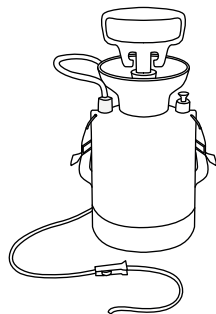

Air pump



Adhesive

* Etc - Storage case

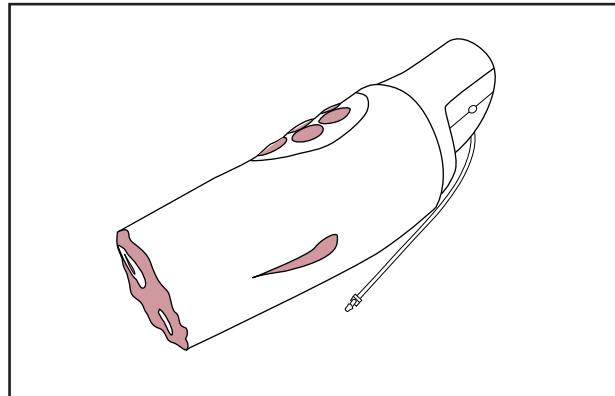

(1) Amputated left leg module (bleeding)

① How to install Amputated left leg module

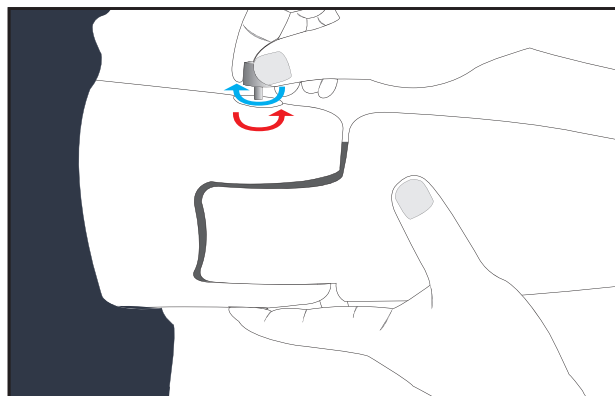
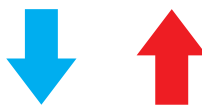
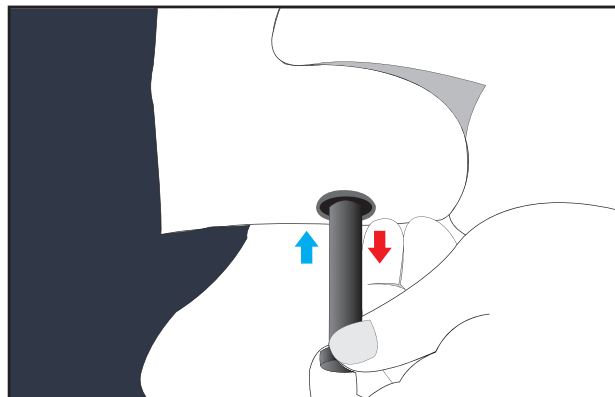

Remove the normal leg and install the amputated left leg module.



 Assemble
 Disassemble

* Assemble/disassemble by turning the knob bolt by hand.

② How to connect the bleeding air pump

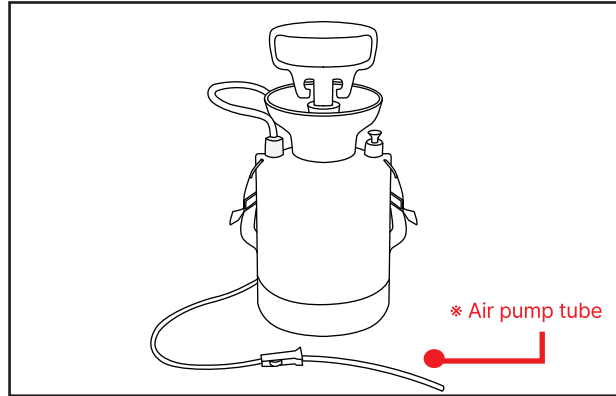

Prepare an air pump for bleeding.

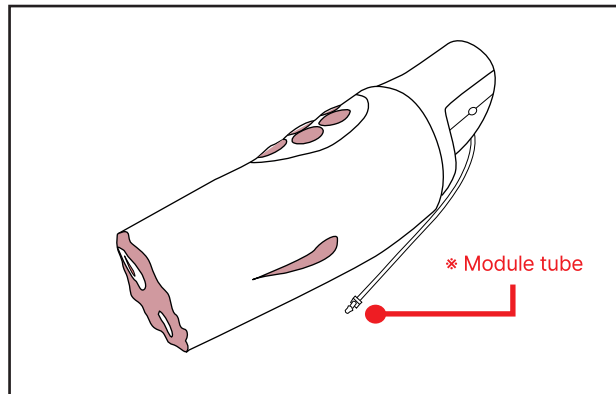

Prepare the module tube of the amputated leg.

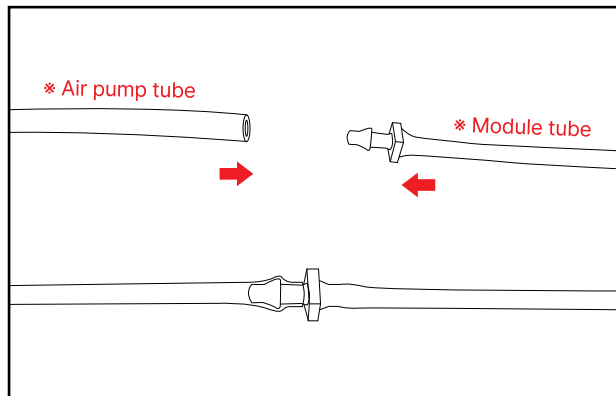

Connect the Air pump tube with the Module tube.

③ Bleeding and hemostasis

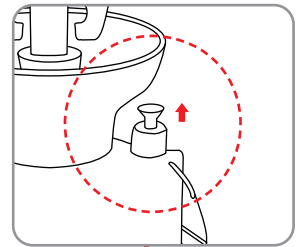
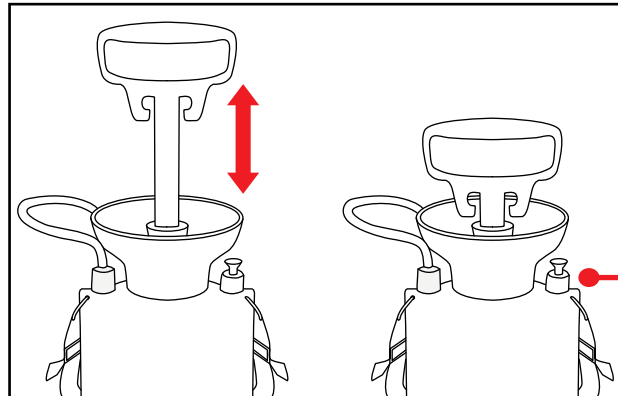

* After practice, pull the valve upward to relieve pump pressure.

Pump the air pump handle 10-15 times.

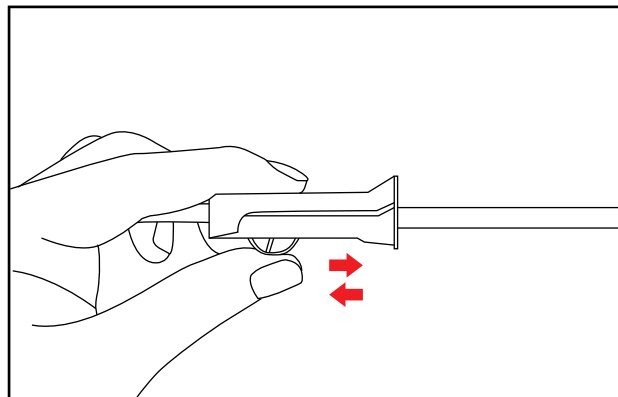

Control the amount of bleeding with a roller clamp.

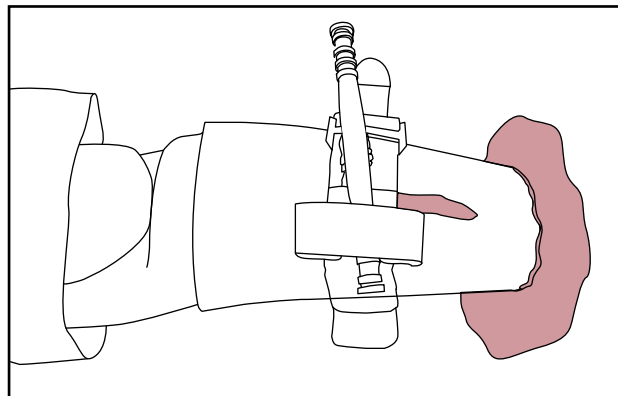

If bleeding occurs, stop it by using a twist tourniquet.

(2) Open fractured right leg module (bleeding)

- ① How to install the open fractured right leg module

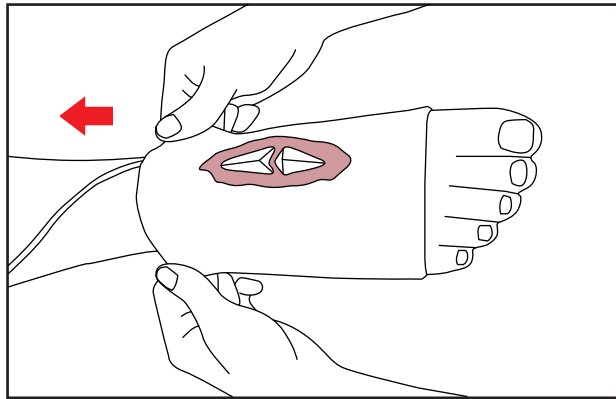

Attach the open fractured leg module to the normal leg.

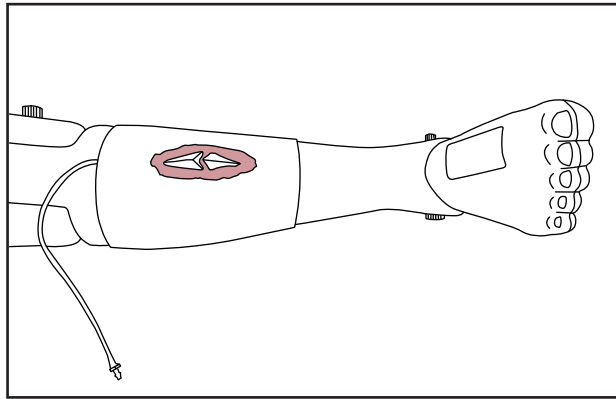

② How to connect the bleeding air pump

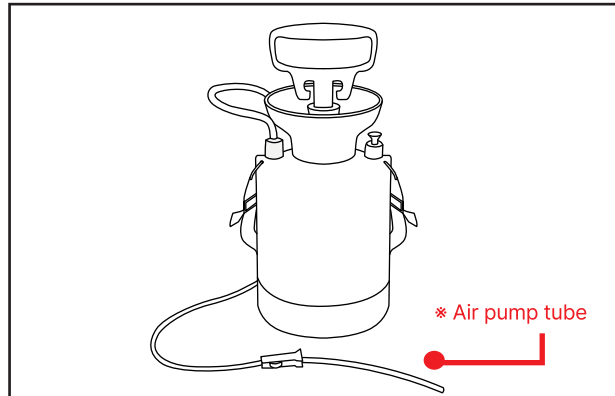

Prepare an air pump for bleeding.

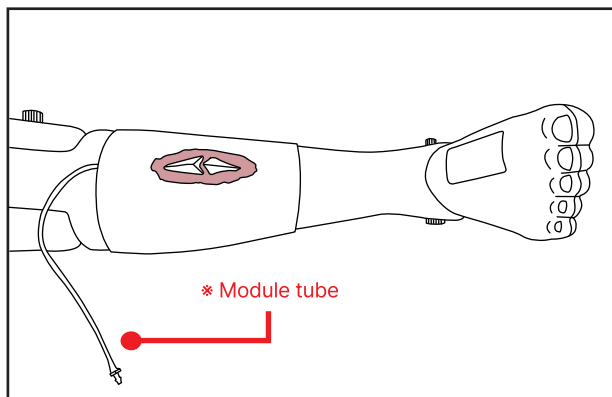

Prepare the tube for the leg module.

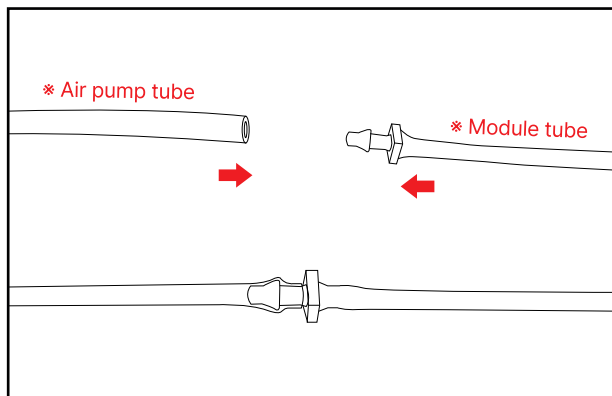

Connect the Air pump tube with the Module tube.

③ Bleeding and hemostasis

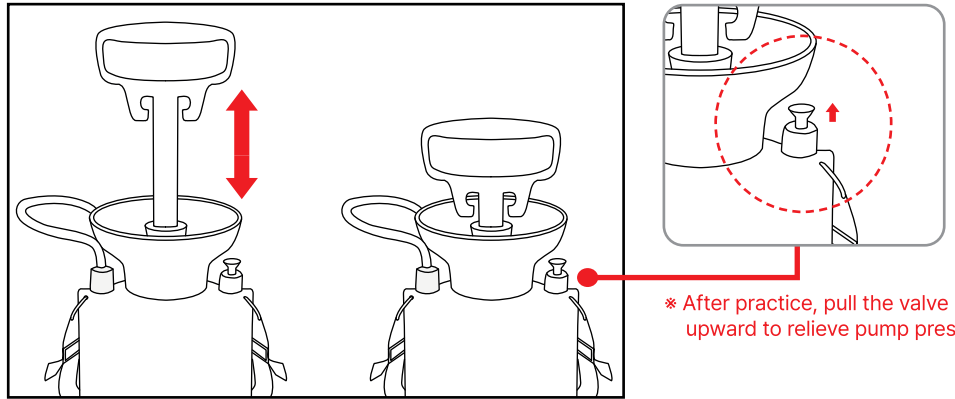

* After practice, pull the valve upward to relieve pump pressure.

Pump the air pump handle 10-15 times.

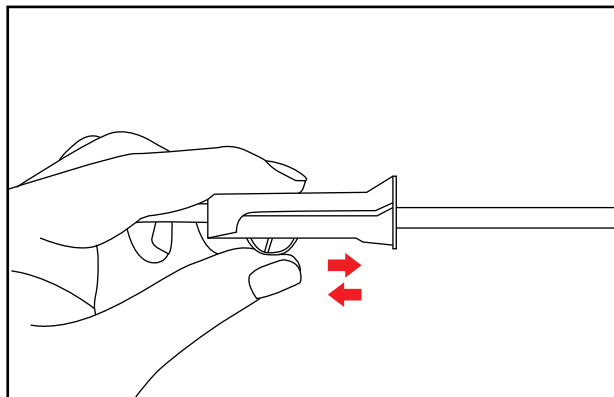

Control the amount of bleeding with a roller clamp.

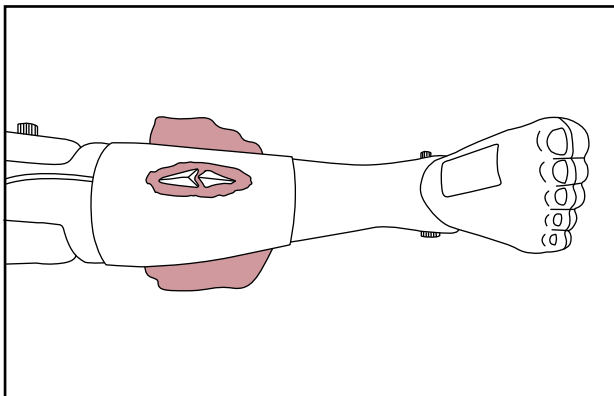

If bleeding occurs, use gauze and a bandage to stop the bleeding.

(3) Open fractured right arm module (bleeding)

① How to install open fractured right arm module

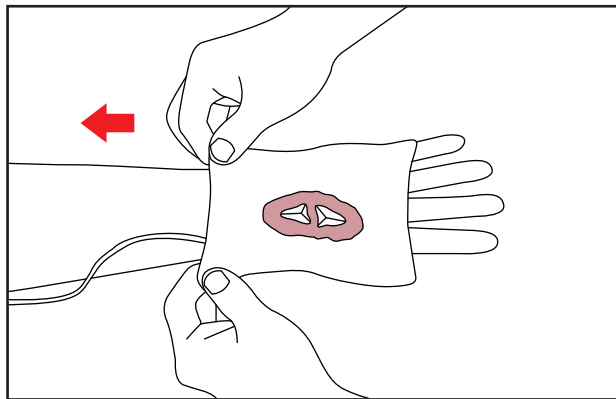

Place the open fractured right arm module on the right arm.

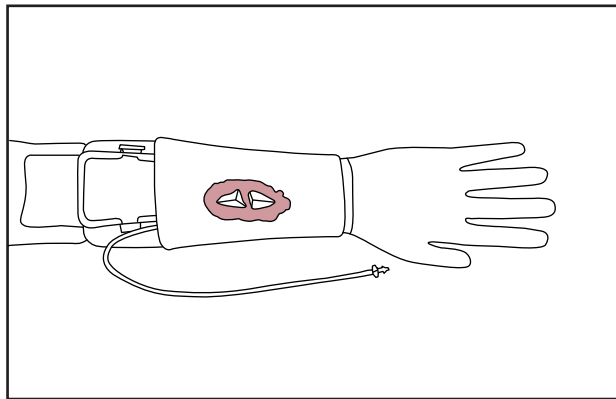

② How to connect the bleeding air pump

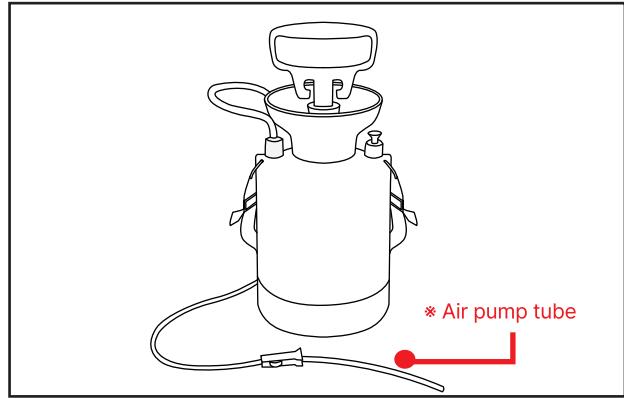

Prepare and air pump for bleeding.

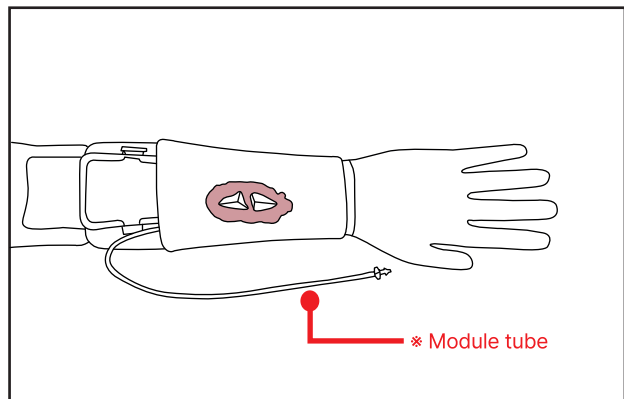

Prepare the tube for the arm module.

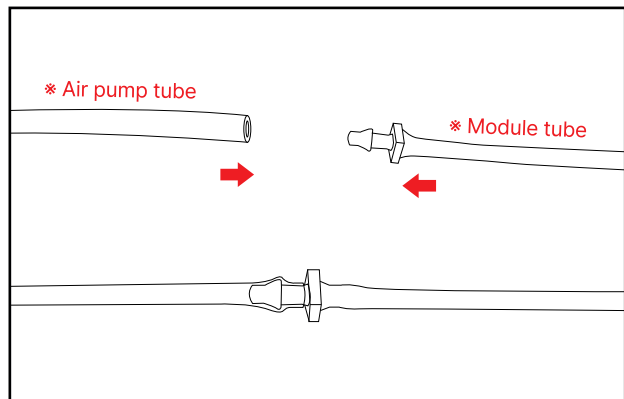

Connect the Air pump tube with the Module tube.

③ Bleeding and hemostasis

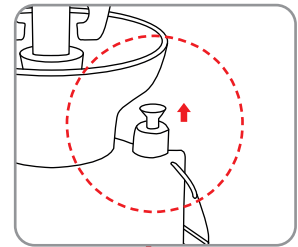
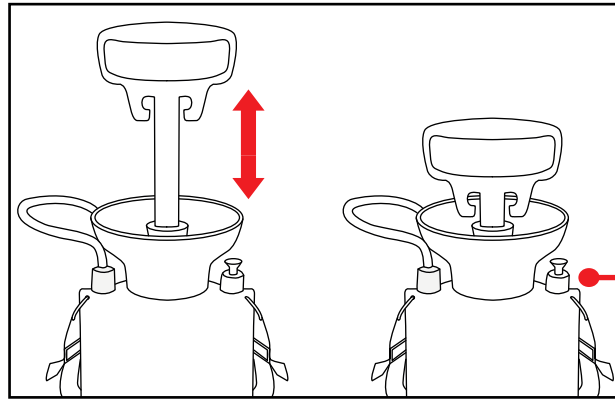

* After practice, pull the valve upwards to relieve pump pressure.

Pump the air pump handle 10-15 times.

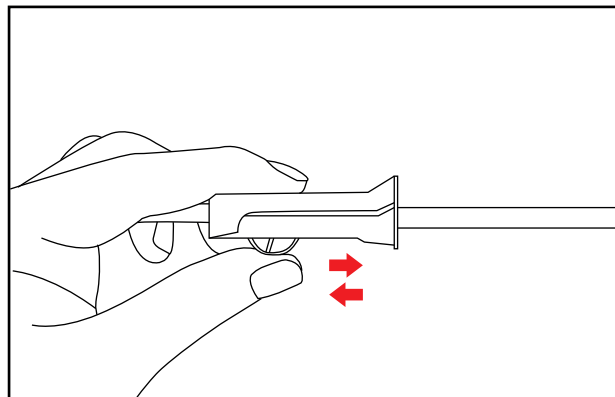

Control the amount of bleeding with a roller clamp.

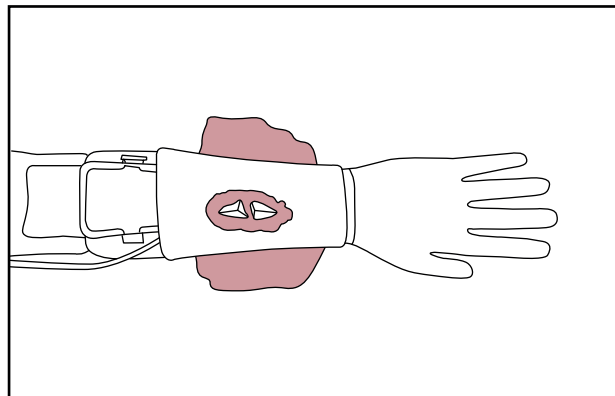

If bleeding occurs, use gauze and a bandage to stop the bleeding.

(4) Attachable wound module (5 modules)

① How to attach an attachable wound module

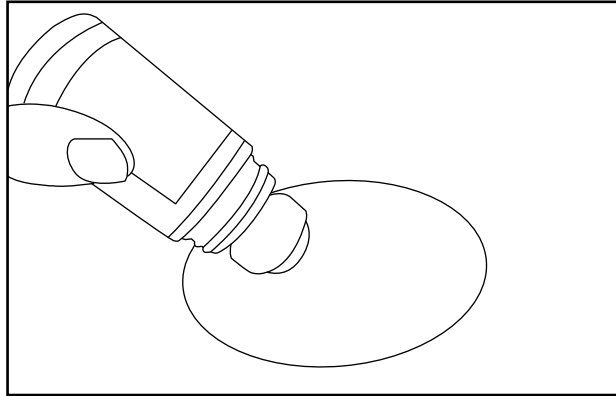

Apply the human body adhesive evenly to the back of the wound module.

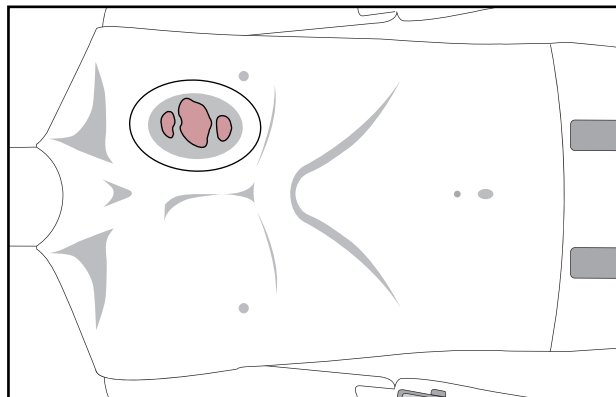

Attach the wound module to the desired location.

② How to clean after detaching the wound module

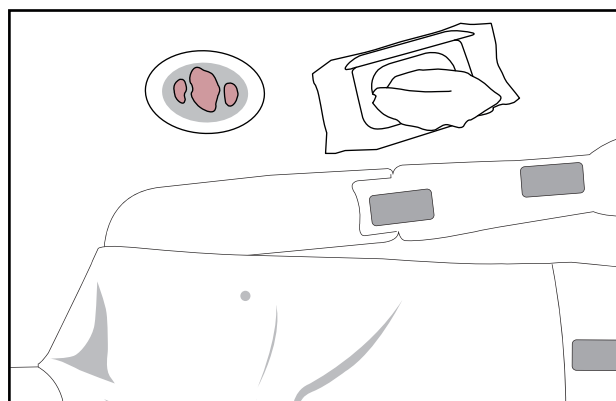

After removal, wipe the human body model and the back of the wound module with a wet tissue/towel.

(5) Attachable wound module small size (5 modules)

① How to attach an attachable wound - small size

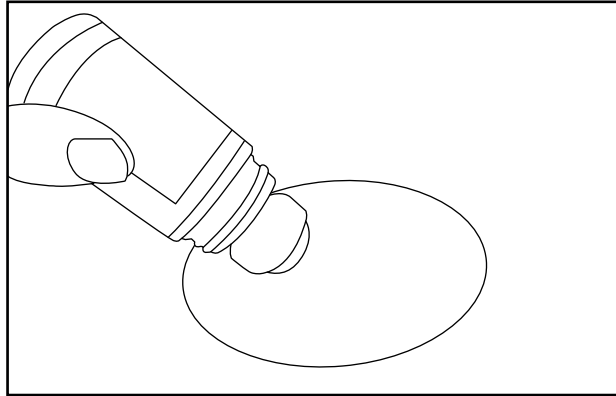

Apply the human body adhesive evenly to the back of the wound module.

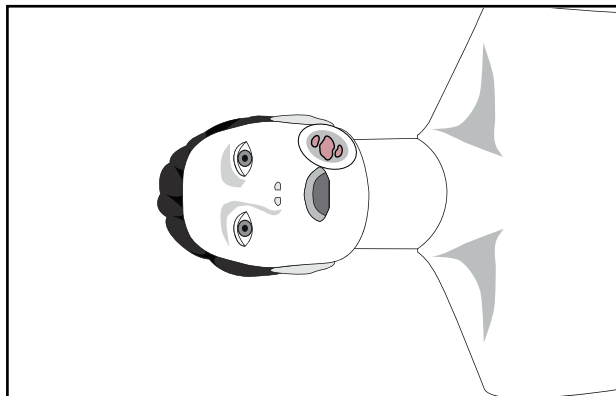

Attach the wound to the desired location.

② How to clean after detaching the wound module

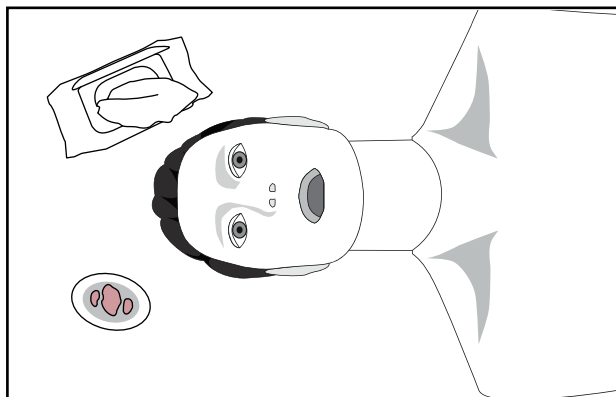

After removal, wipe the human body model and the back of the wound module with a wet tissue/towel.

BT-TRAUMA KIT

Trauma Training Model

경기도 고양시 덕양구 통일로 140, A동 313호(동산동, 삼성테크노밸리)
Homepage: www.btinc.co.kr / E-mail: bt@btinc.co.kr
Tel: +82-2-2038-2903, +82-51-903-1144 / Fax: +82 303-3130-0607

Copyright(c) BT Inc. All rights reserved.